

Specification Sheet

821.000.075 S BEND, LONG 87.5°, 50 MM

-Diameter: Ø75mm
-Stainless steel: AISI316L/EN1.4404

Product Codes

EAN: 5705499404036
VVS Number:
RSK Number: 1551560
NRF Number: 2172537
LVI Number:

Specification

Angle (°): 87.5
Length (mm): 90
Material: AISI 316L
Material (EN): EN 1.4404
Outlet Diameter (mm): 75
Type: Bends
Weight (kg): 0,50

Approvals



NO - 0692-16



SE - SITAC 4423/90-17



DK - VA 2.12/19349-19

MARINE - R4547 NATO CODIFICATION SYSTEM
Lloyds Register 92-00041 (E7)
RU - 0212322 Pipes-18
ABS - 18-LD1716353-PDA
PL - Hygienic Certificate - All products
RINA -MAC285119XG EuroPipe
RS - 19.10097.262
Achilles Certificate - 25316-20
KR - Type Approval CPH42135-PE001

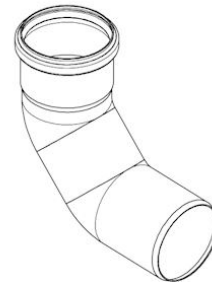
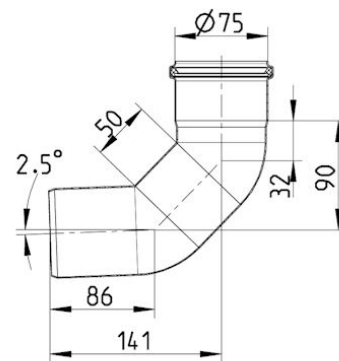

BLÜCHER®

A WATTS Brand